

550mm DRAWER RUNNER

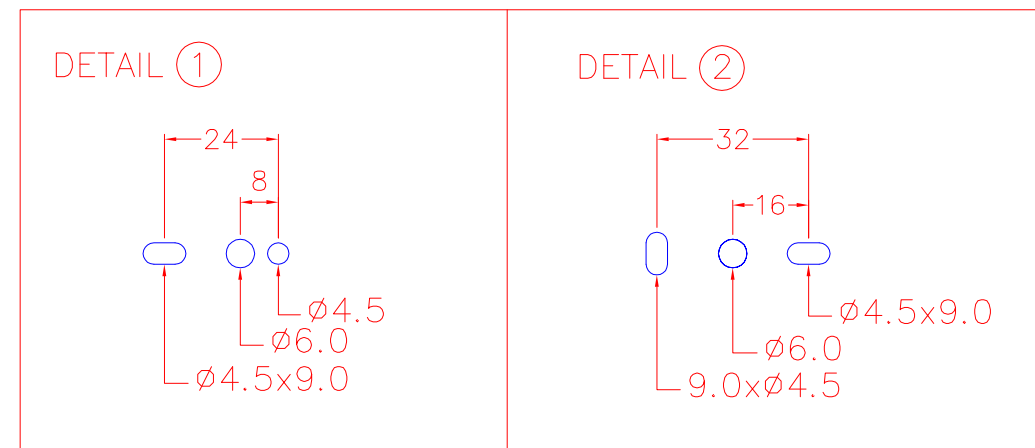
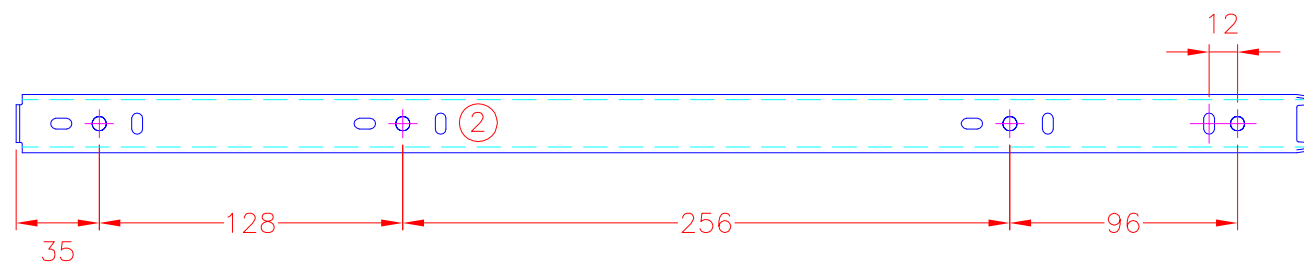
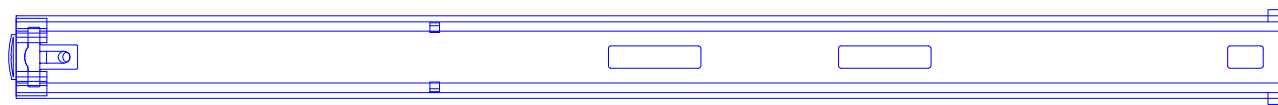
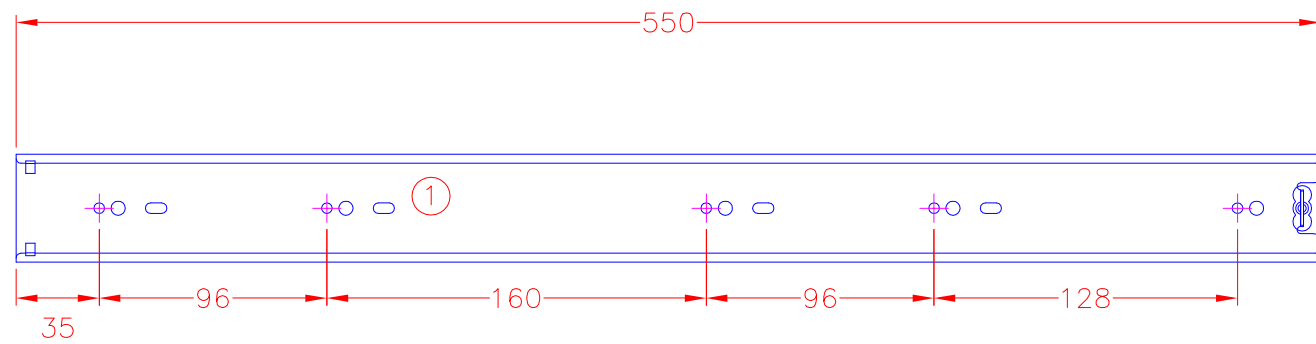
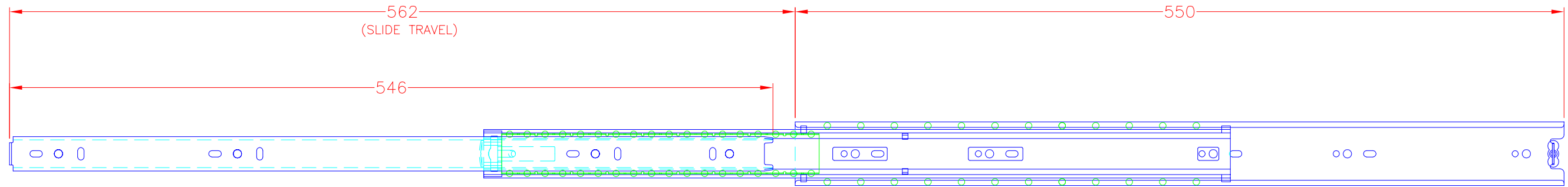

NOTE
HOLE CENTRES TO BE CONFIRMED BY US.
DO NOT DRILL ANY FIXING HOLES TO MATCH
DRAWER SLIDES UNTIL WE HAVE CONFIRMED
DIMENSIONS.

PART No: JS DR13